

HYDRAULIC MOTORS MM

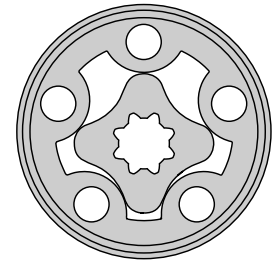

CONTENTS

Specification data 5
 Function diagrams 6÷8
 Dimensions and mounting ... 9
 Shaft extensions 10
 Permissible shaft loads 10
 Order code 11

OPTIONS

- » Model- Spool valve, gerotor
- » With or without flange
- » Side and rear ports
- » Series with pressure valve(s)
- » Shafts- straight and splined
- » Metric and BSPP ports
- » Speed sensing;

GENERAL

Displacement,	[cm ³ /rev.]	8,2÷50
Max. Speed,	[RPM]	400÷1950
Max. Torque,	[daNm]	1,1÷4,5
Max. Output,	[kW]	1,8÷2,4
Max. Pressure Drop,	[bar]	70÷100
Max. Oil Flow,	[l/min]	16÷20
Min. Speed,	[RPM]	20÷50
Pressure fluid		Mineral based- HLP(DIN 51524) or HM(ISO 6743/4)
Temperature range,	[°C]	-30÷90
Optimal Viscosity range,	[mm ² /s]	20÷75
Filtration		ISO code 20/16 (Min. recommended fluid filtration of 25 micron)

MMP Series with Integrated Internal Crossover Relief Valve
A → B, Δp = 100 bar (50 bar)

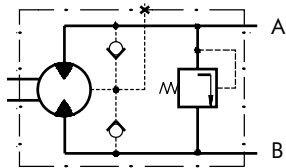

MMP Series with Integrated Internal Crossover Relief Valve
B → A, Δp = 100 bar (50 bar)

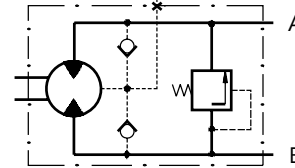

Pressure Losses

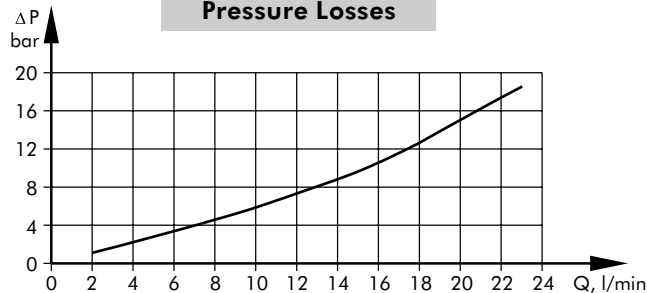

MMD Series with Integrated Internal Crossover Relief Valves
A ↔ B, Δp = 100 bar (50 bar)

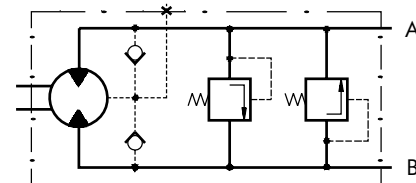

SPECIFICATION DATA

Type		MM 8	MM 12,5	MM 20	MM 32	MM 40	MM 50
Displacement [cm ³ /rev.]		8,2	12,9	20	31,8	40	50
Max. Speed, [RPM]	cont.	1950	1550	1000	630	500	400
	int.*	2440	1940	1250	790	625	500
Max. Torque [daNm]	cont.	1,1	1,6	2,5	4	4,1	4,5
	int.*	1,5	2,3	3,5	5,7	5,7	5,8
	peak**	2,1	3,3	5,1	6,4	6,6	8
Max. Output [kW]	cont.	1,8	2,4	2,4	2,4	1,8	1,7
	int.*	2,6	3,2	3,2	3,2	3,0	2,1
Max. Pressure Drop [bar]	cont.	100	100	100	100	80	70
	int.*	140	140	140	140	110	90
	peak**	200	200	200	200	140	125
Max. Oil Flow [l/min]	cont.	16	20	20	20	20	20
	int.*	20	25	25	25	25	25
Max. Inlet Pressure, [bar]	cont.	140	140	140	140	140	140
	int.*	175	175	175	175	175	175
	peak**	225	225	225	225	225	225
Max. Return Pressure w/o Drain Line or Max. Pressure in Drain Line, [bar]	cont.	0-100 RPM	140	140	140	140	140
	cont.	100-400 RPM	100	100	100	100	100
	cont.	400-800 RPM	50	50	50	50	-
	cont.	>800 RPM	20	20	20	-	-
	int.*	0-max. RPM	140	140	140	140	140
Max. Return Pressure with Drain Line [bar]	cont.		140	140	140	140	140
	int.*		175	175	175	175	175
	peak**		225	225	225	225	225
Max. Starting Pressure with Unloaded Shift, [bar]		4	4	4	4	4	4
Min. Starting Torque [daNm]	at max. press. drop cont.	0,7	1,2	2,1	3,4	3,3	3,7
	at max. press. drop int.*	1,0	1,7	2,9	4,8	4,6	4,8
Min. Speed***, [RPM]		50	40	30	30	25	20
Weight, avg. [kg]	MM	1,9	2	2,1	2,2	2,3	2,5
	MMF(S)	2,3	2,4	2,5	2,6	2,7	2,9
	MMFS	2,7	2,8	2,9	3,0	3,1	3,3
	MMP	2,5	2,6	2,7	2,8	2,9	3,1
	MMPF	2,7	2,8	2,9	3,0	3,1	3,3
	MMD	2,6	2,7	2,8	2,9	3,0	3,2
	MMDF	2,8	2,9	3,0	3,1	3,2	3,4

* Intermittent operation: the permissible values may occur for max. 10% of every minute.

** Peak load: the permissible values may occur for max. 1% of every minute.

*** For speeds of 30 RPM or lower, consult factory or your regional manager.

1. Intermittent speed and intermittent pressure drop must not occur simultaneously.
2. Recommended filtration is per ISO cleanliness code 20/16. A nominal filtration of 25 micron or better.
3. Recommend using a premium quality, anti-wear type mineral based hydraulic oil HLP(DIN51524) or HM (ISO 6743/4).
If using synthetic fluids consult the factory for alternative seal materials.
4. Recommended minimum oil viscosity 13 mm²/s at operating temperature 50°C.
5. Recommended maximum system operating temperature is 82°C.
6. To assure optimum motor life fill with fluid prior to loading and run at moderate load and speed for 15-30 min.

FUNCTION DIAGRAMS

MM 8

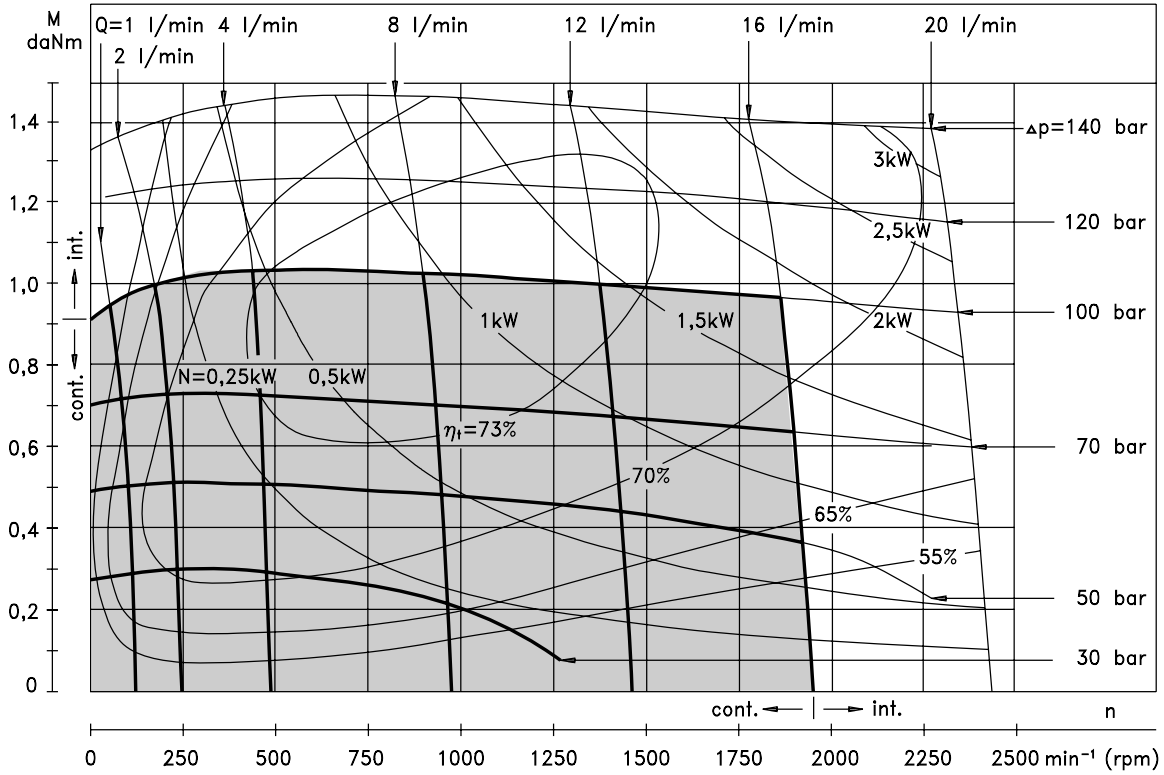

MM 12,5

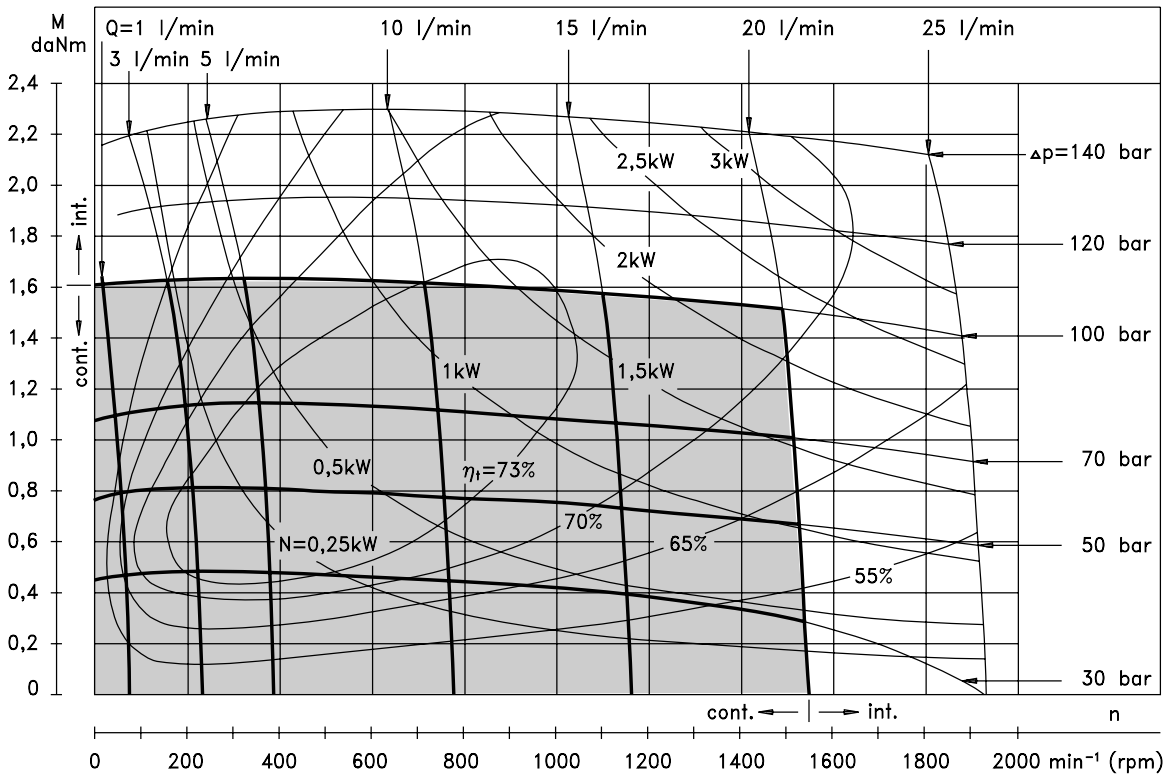

The function diagrams data was collected at back pressure 5 ÷ 10 bar and oil with viscosity of 32 mm²/s at 50° C.

FUNCTION DIAGRAMS

MM 20

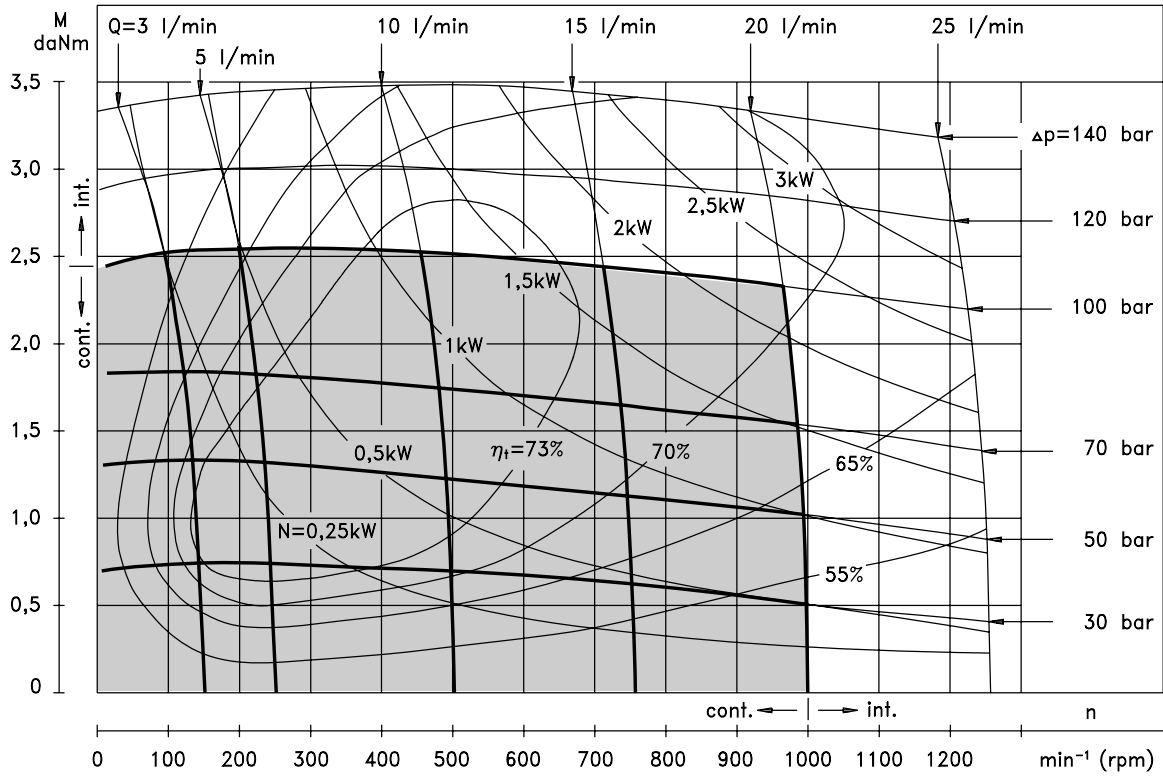

MM 32

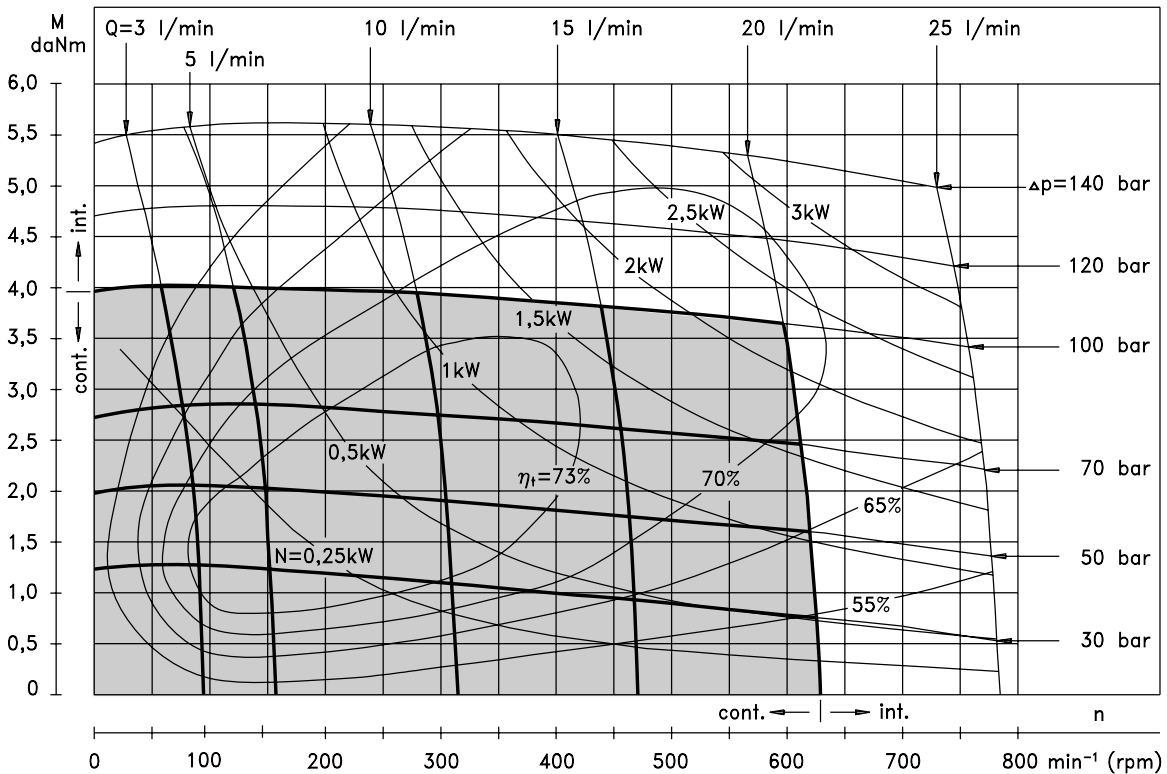

The function diagrams data was collected at back pressure 5 ± 10 bar and oil with viscosity of $32 \text{ mm}^2/\text{s}$ at 50°C .

FUNCTION DIAGRAMS

MM 40

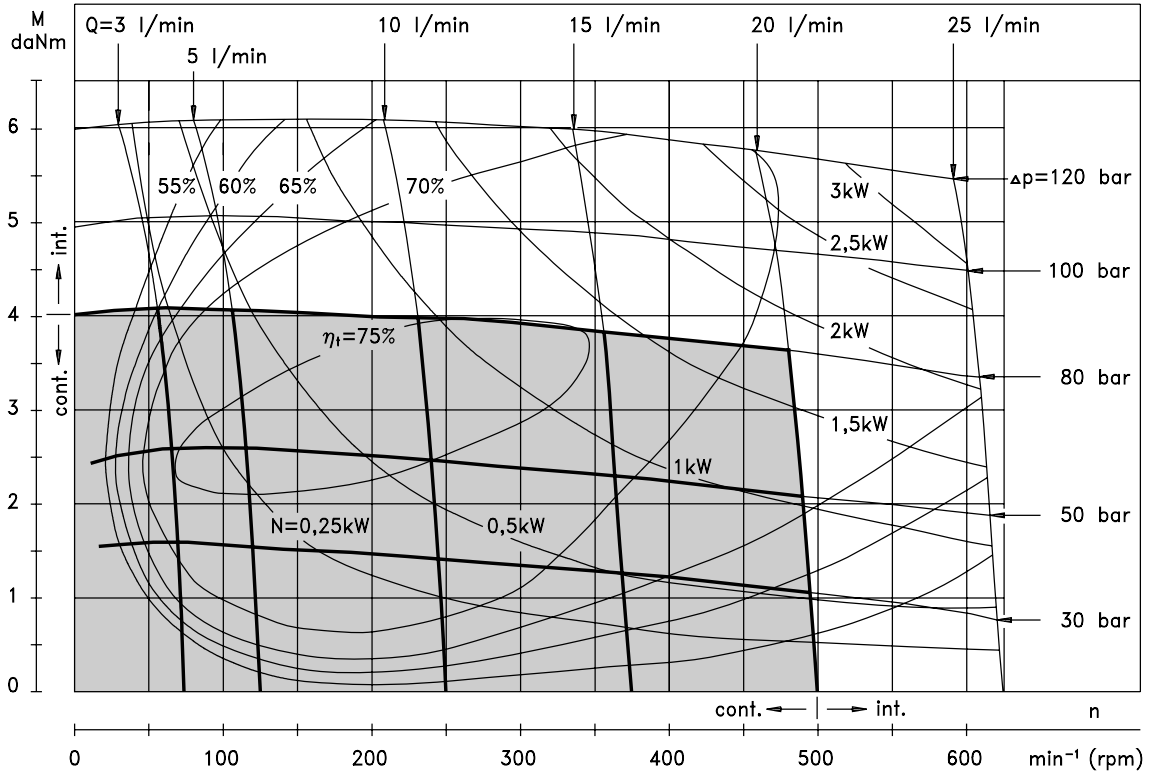

MM 50

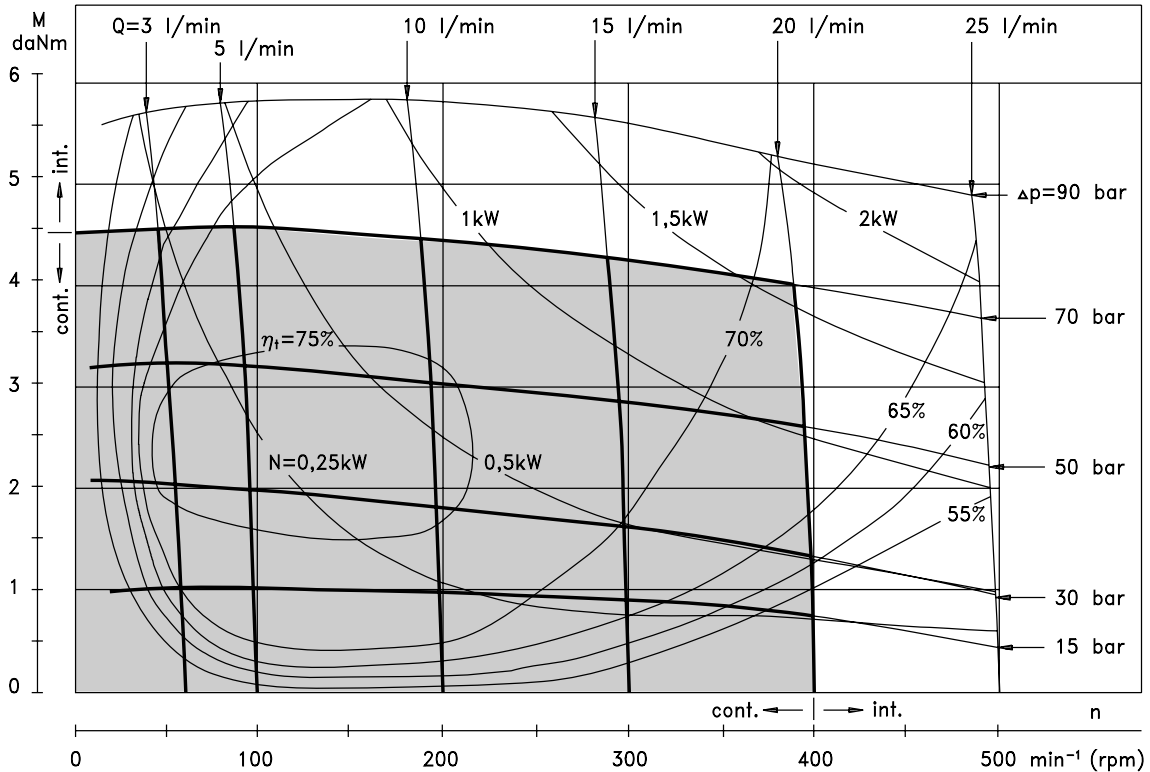

The function diagrams data was collected at back pressure 5 ÷ 10 bar and oil with viscosity of 32 mm²/s at 50° C.

DIMENSIONS AND MOUNTING DATA

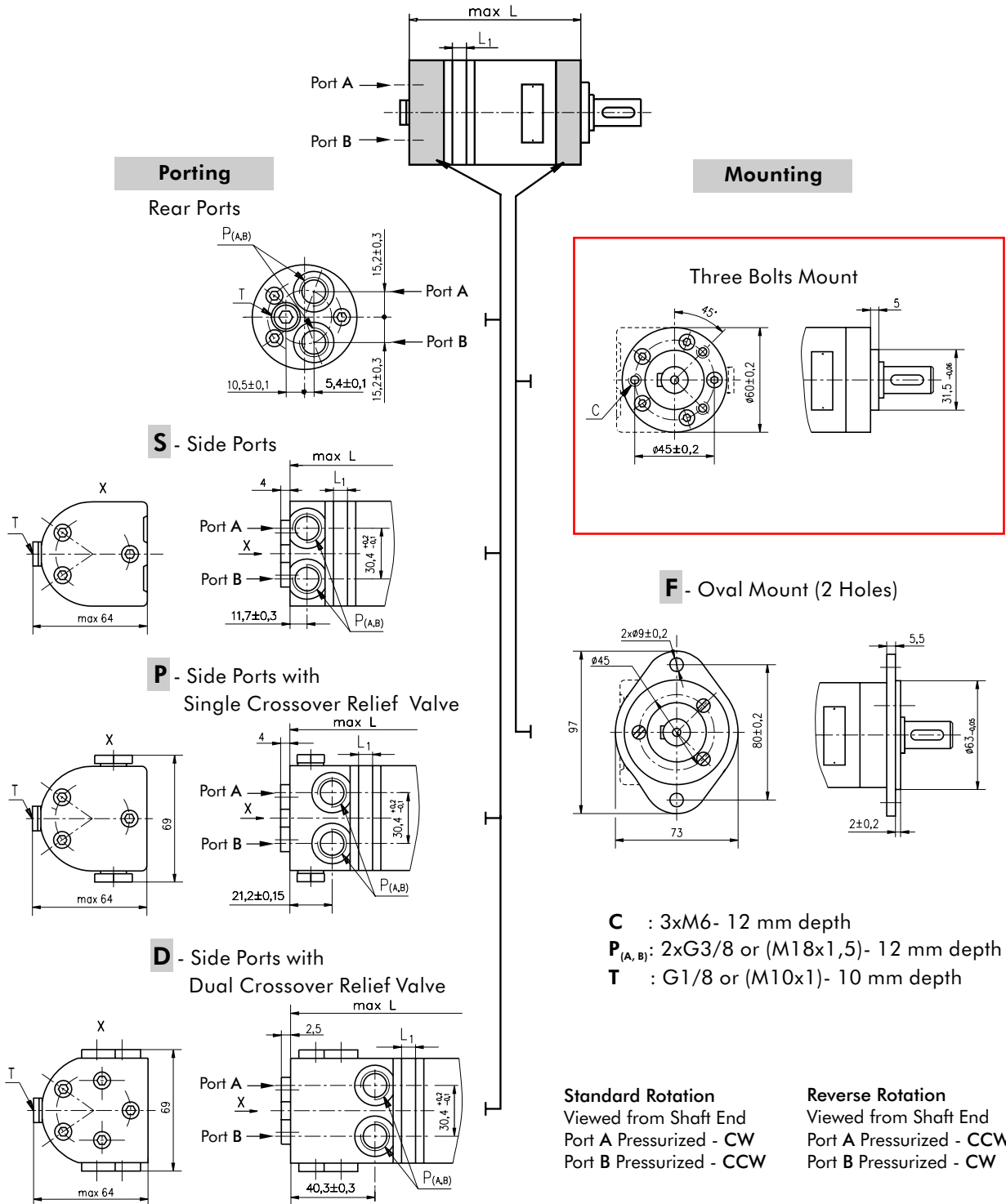

Type	L,mm	Type	L,mm	Type	L,mm	Type	L,mm	L ₁ ,mm
MM 8	104	MMS 8	105	MMP 8	115	MMD 8	134	3,5
MM12,5	106	MMS12,5	107	MMP12,5	117	MMD12,5	136	5,5
MM 20	109	MMS 20	110	MMP 20	120	MMD 20	139	8,5
MM 32	114	MMS 32	115	MMP 32	125	MMD 32	144	13,5
MM 40	117,5	MMS 40	118,5	MMP 40	128,5	MMD 40	147,5	17
MM 50	121,5	MMS 50	122,5	MMP 50	132,5	MMD 50	151,5	21

SHAFT EXTENSIONS

C - $\varnothing 16$ straight, Parallel key 5x5x16 DIN 6885
Max. Torque 3,9 daNm

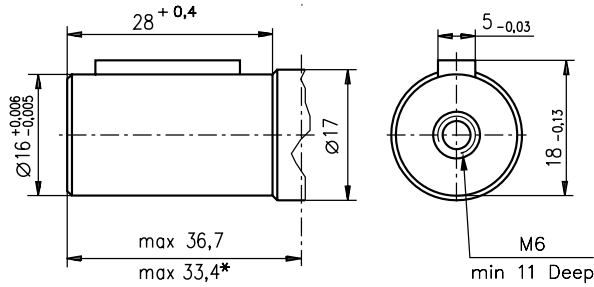

CK - $\varnothing 14$ Straight, Parallel key 5x5x16 DIN 6885
Max. Torque 3 daNm

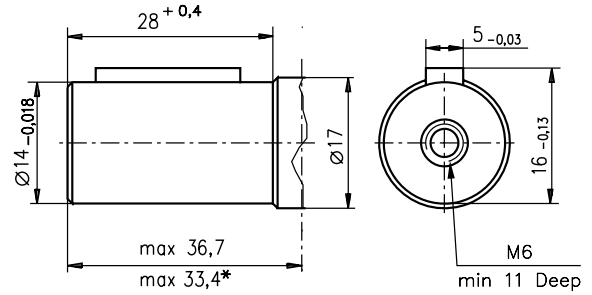

SH - $\varnothing 16,5$ Splined, B17x14 DIN 5482
Max. Torque 4,4 daNm

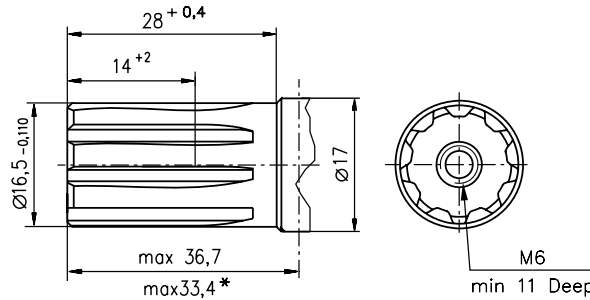

- Motor Mounting Surface
* For **F** Mounting

PERMISSIBLE SHAFT LOAD

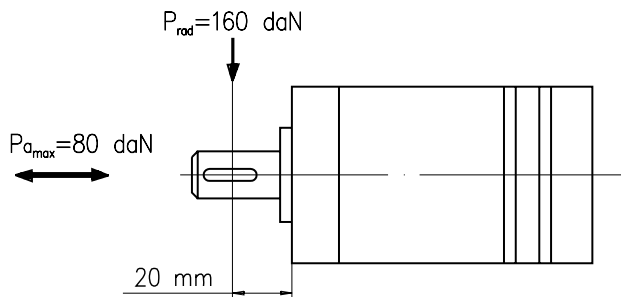

The permissible radial shaft load [Prad] is calculated from the distance [L] between the point of load application and the mounting surface:

$$P_{rad} = \frac{600}{n} \times \frac{13040}{(61,5+L)}, \text{ [daN]}$$

[L in mm; L ≤ 80]

The drawing shows the permissible radial load when L=20 mm.

If the calculated shaft load exceeds the permissible, a flexible coupling must be used.

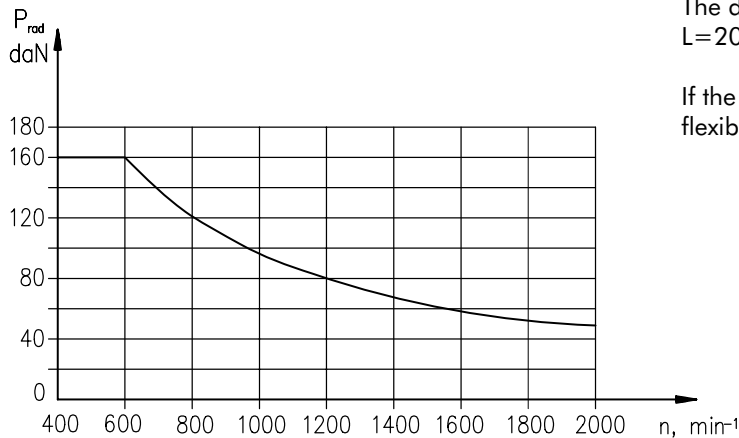

ORDER CODE

	1	2	3	4	5	6	7	8	9	10
MM										

Pos.1 - Adjustment Option

omit - without valve

P - Side ports with single crossover relief valve

D - Side ports with dual crossover relief valve

Pos.2 - Mounting Flange

omit - Three bolts mount

F -Oval mount, two holes

Pos.3 - Port type (not valid for **P** and **D** version)

omit - Rear ports

S - Side ports

Pos.4 - Displacement code

8 - 8,2 [cm³/rev]

12,5 - 12,9 [cm³/rev]

20 - 20,0[cm³/rev]

32 - 31,8[cm³/rev]

40 - 40,0[cm³/rev]

50 - 50,0[cm³/rev]

Pos. 5 - Shaft Extensions*

C - ø16 straight, Parallel key 5x5x16 DIN 6885

VC - ø16 straight, Parallel key 5x5x16 DIN 6885
with corrosion resistant bushing

CK - ø14 straight, Parallel key 5x5x16 DIN 6885

SH - ø16,5 splined, B17x14 DIN 5482

Pos. 6 - Ports

omit - BSPP (ISO 228)

M - Metric (ISO 262)

Pos. 7 - Line to controled ** (see page 4)

/L - B→A (left running)

/R - A→B (right running)

Pos. 8 - Valve Rated Pressure ***

/50 - Δp=50 bar

/100 - Δp=100 bar

Pos. 9 - Special Features (see page 46)

Pos.10 - Design Series

omit - Factory specified

NOTES:

* The permissible output torque for shafts must not be exceeded!

** For "P" option useful only.

*** For "P" and "D" option useful only.

The hydraulic motors are mangano-phosphatized as standard.

F - FLANGE KIT (2 Holes)

Order No:48443 014 00

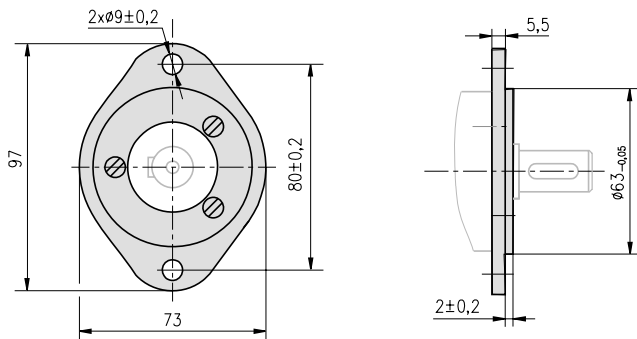

Flange Kit includes 3 screws - M6x14
for attaching flange to the motor.